

Ambient Light Sensor, RoHS Compliant



20118

DESCRIPTION

TEPT5700 ambient light sensor is a silicon NPN epitaxial planar phototransistor in a T-1 $\frac{3}{4}$ package. It is sensitive to visible light much like the human eye and has peak sensitivity at 570 nm.

FEATURES

- Package type: leaded
- Package form: T-1 $\frac{3}{4}$
- Dimensions (in mm): \varnothing 5
- High photo sensitivity
- Adapted to human eye responsivity
- Angle of half sensitivity: $\varphi = \pm 50^\circ$
- Lead (Pb)-free component in accordance with RoHS 2002/95/EC and WEEE 2002/96/EC

RoHS
COMPLIANT

APPLICATIONS

- Ambient light sensor for control of display backlight dimming in LCD displays and keypad backlighting of mobile devices and in industrial on/off-lighting operation

PRODUCT SUMMARY

COMPONENT	I_{PCE} (mA)	φ (deg)	$\lambda_{0.5}$ (nm)
TEPT5700	75	± 50	440 to 800

Note

Test condition see table "Basic Characteristics"

ORDERING INFORMATION

ORDERING CODE	PACKAGING	REMARKS	PACKAGE FORM
TEPT5700	Bulk	MOQ: 4000 pcs, 4000 pcs/bulk	T-1 $\frac{3}{4}$

Note

MOQ: minimum order quantity

ABSOLUTE MAXIMUM RATINGS

PARAMETER	TEST CONDITION	SYMBOL	VALUE	UNIT
Collector emitter voltage		V_{CEO}	6	V
Emitter collector voltage		V_{ECO}	1.5	V
Collector current		I_C	20	mA
Power dissipation	$T_{amb} \leq 55^\circ\text{C}$	P_V	100	mW
Junction temperature		T_j	100	$^\circ\text{C}$
Operating temperature range		T_{amb}	- 40 to + 85	$^\circ\text{C}$
Storage temperature range		T_{stg}	- 40 to + 100	$^\circ\text{C}$
Soldering temperature	$t \leq 5$ s, 2 mm distance to package	T_{sd}	260	$^\circ\text{C}$
Thermal resistance junction/ambient	J-STD-051, soldered on PCB	R_{thJA}	230	K/W

Note
 $T_{amb} = 25^\circ\text{C}$, unless otherwise specified

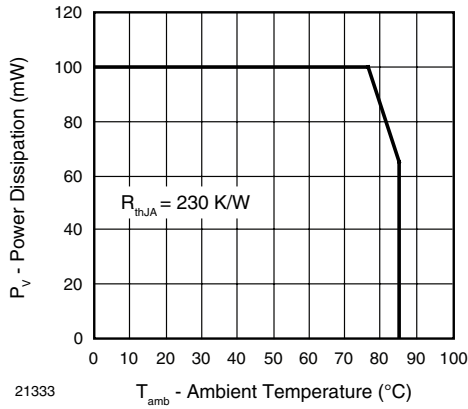

Fig. 1 - Power Dissipation Limit vs. Ambient Temperature

BASIC CHARACTERISTICS						
PARAMETER	TEST CONDITION	SYMBOL	MIN.	TYP.	MAX.	UNIT
Collector emitter breakdown voltage	$I_C = 0.1 \text{ mA}$	V_{CE0}	6			V
Collector dark current	$V_{CE} = 5 \text{ V}, E = 0$	I_{CE0}		3	50	nA
Collector emitter capacitance	$V_{CE} = 0 \text{ V}, f = 1 \text{ MHz}, E = 0$	C_{CE0}		16		pF
Collector light current	$E_v = 20 \text{ lx}, \text{ CIE illuminant A}, V_{CE} = 5 \text{ V}$	I_{PCE}	5.2	15	24	μA
	$E_v = 100 \text{ lx}, \text{ CIE illuminant A}, V_{CE} = 5 \text{ V}$	I_{PCE}		75		μA
Angle of half sensitivity		ϕ		± 50		deg
Wavelength of peak sensitivity		λ_p		570		nm
Range of spectral bandwidth		$\lambda_{0.5}$		440 to 800		nm
Collector emitter saturation voltage	$E_v = 20 \text{ lx}, \text{ CIE illuminant A}, I_{PCE} = 1.2 \mu\text{A}$	V_{CEsat}		0.1		V

Note

$T_{amb} = 25 \text{ }^\circ\text{C}$, unless otherwise specified

BASIC CHARACTERISTICS

$T_{amb} = 25 \text{ }^\circ\text{C}$, unless otherwise specified

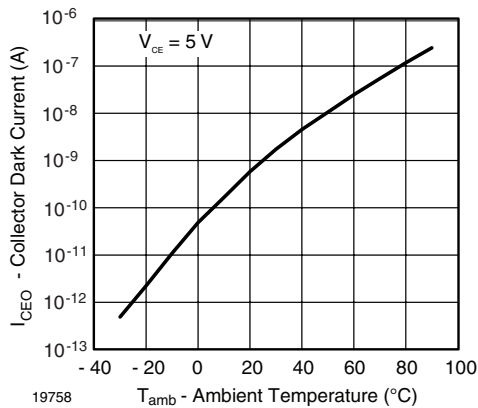

Fig. 2 - Collector Dark Current vs. Ambient Temperature

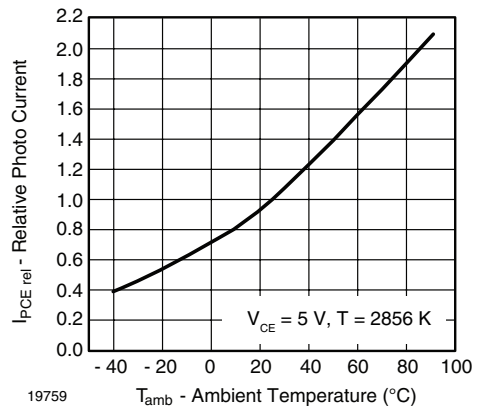

Fig. 3 - Relative Photo Current vs. Ambient Temperature

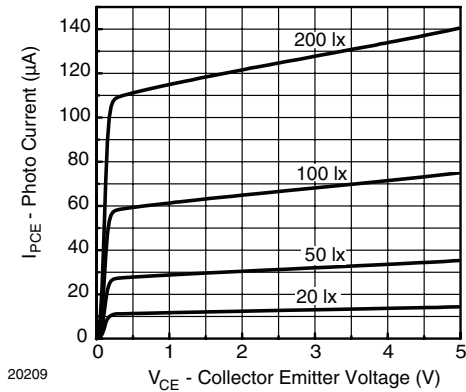

Fig. 4 - Photo Current vs. Collector Emitter Voltage

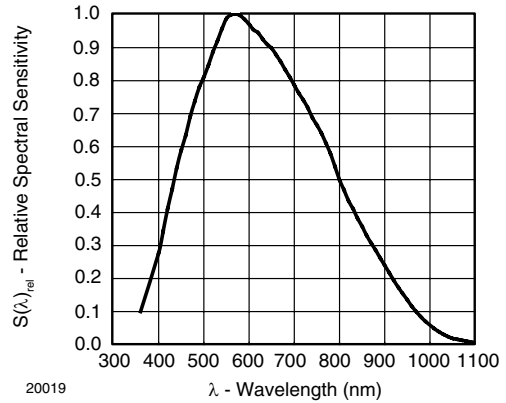

Fig. 7 - Relative Spectral Sensitivity vs. Wavelength

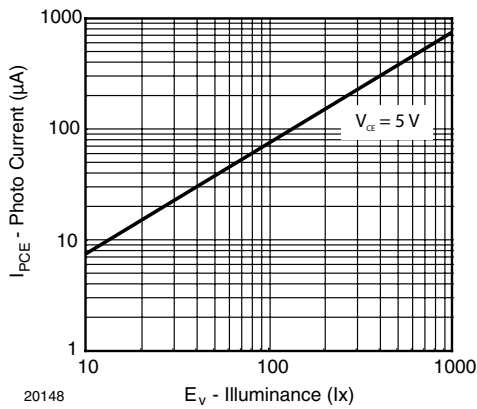

Fig. 5 - Photo Current vs. Illuminance

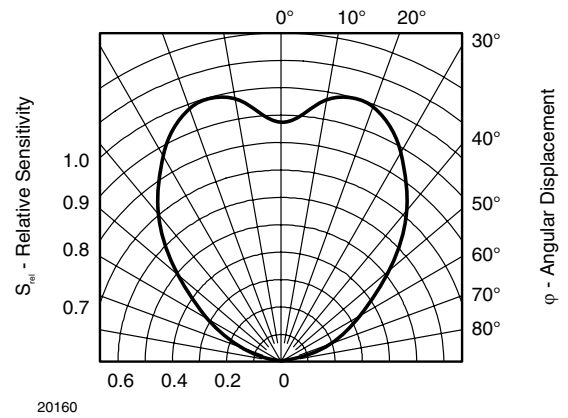

Fig. 8 - Relative Radiant Sensitivity vs. Angular Displacement

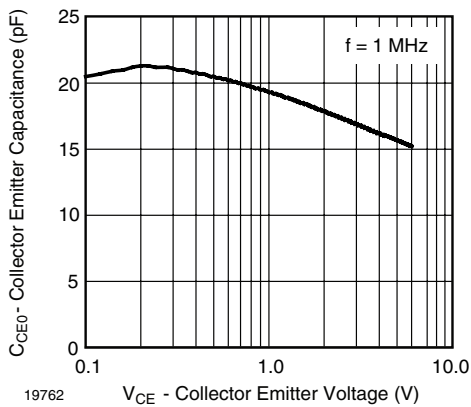
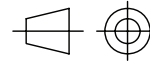
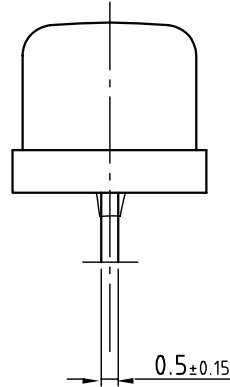
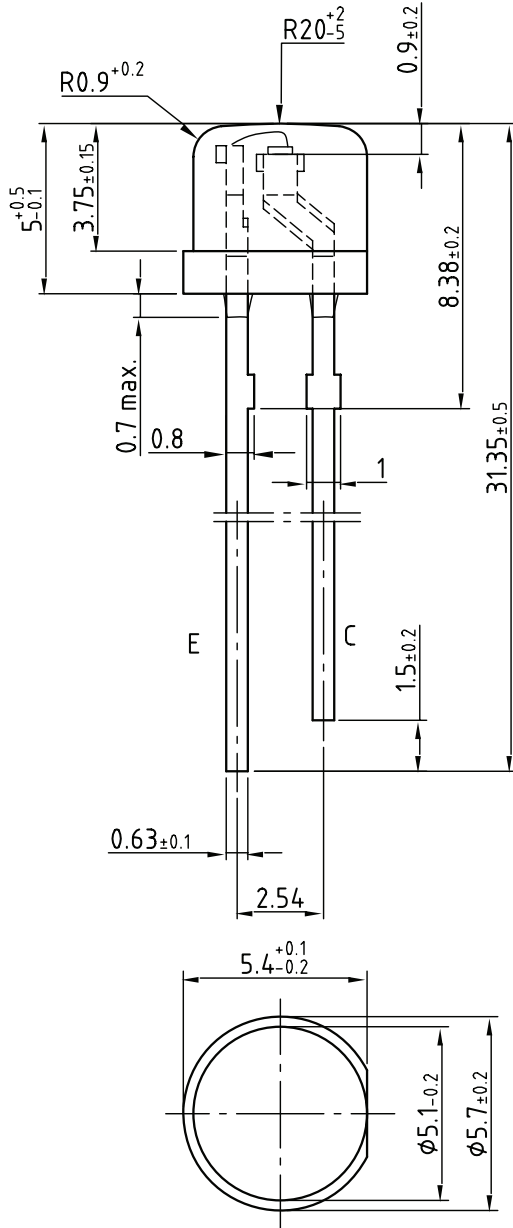

Fig. 6 - Collector Emitter Capacitance vs. Collector Emitter Voltage

PACKAGE DIMENSIONS in millimeters



technical drawings
according to DIN
specifications

Dimensions in mm

Not indicated tolerances ± 0.1

Drawing-No.: 6.544-5375.01-4

Issue: 3; 10.11.06

20117



Disclaimer

All product specifications and data are subject to change without notice.

Vishay Intertechnology, Inc., its affiliates, agents, and employees, and all persons acting on its or their behalf (collectively, "Vishay"), disclaim any and all liability for any errors, inaccuracies or incompleteness contained herein or in any other disclosure relating to any product.

Vishay disclaims any and all liability arising out of the use or application of any product described herein or of any information provided herein to the maximum extent permitted by law. The product specifications do not expand or otherwise modify Vishay's terms and conditions of purchase, including but not limited to the warranty expressed therein, which apply to these products.

No license, express or implied, by estoppel or otherwise, to any intellectual property rights is granted by this document or by any conduct of Vishay.

The products shown herein are not designed for use in medical, life-saving, or life-sustaining applications unless otherwise expressly indicated. Customers using or selling Vishay products not expressly indicated for use in such applications do so entirely at their own risk and agree to fully indemnify Vishay for any damages arising or resulting from such use or sale. Please contact authorized Vishay personnel to obtain written terms and conditions regarding products designed for such applications.

Product names and markings noted herein may be trademarks of their respective owners.